



2018 GL1800 – Helpful Tips for Getting Started

This guide helps you get quickly acquainted with your Honda Gold Wing, providing you with reference instructions on select riding controls and convenience features. As with the Owner's Manual, this guide shows features from all Gold Wing trim levels – you may find descriptions of equipment and features that are not on your particular model.

This guide is not intended as a substitute for the Owner's Manual.



Always check the Owner's Manual for more operating and safety information.

Honda SMART Key System

The Honda SMART Key system allows you to operate the motorcycle. The system runs a two-way authentication between the motorcycle and the Honda SMART Key to verify it is the registered Honda SMART Key.

Activate or Deactivate the Honda SMART Key System

■ To Switch the Honda SMART Key System to Activation or Deactivation

Press and hold the ON/OFF button for more than 1 second.

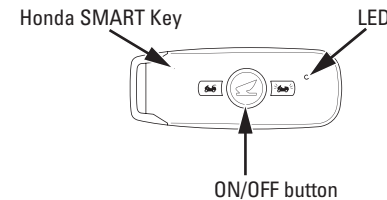

■ To Check the Honda SMART Key System Status

Press the ON/OFF button for less than 1 second. The LED of the Honda SMART Key will show the status.

When the LED of the Honda SMART Key:

- Blinks 3 times: Honda SMART Key system authentication can be performed.
- Lights briefly: Honda SMART Key system authentication cannot be performed.

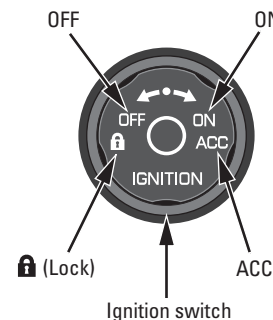

Operating the Ignition Switch

■ To Activate the Electrical System

1. Make sure that the Honda SMART Key is activated and enter the operating range for the motorcycle.

The system can be operated when the Honda SMART Key is within the shaded area as shown.

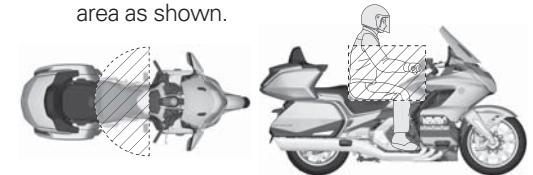

2. Turn the ignition switch to ON.
 - ▶ The electrical system activates and the engine can be started.

For the engine starting procedure, refer to the Owner's Manual.

■ To Turn Off the Electrical System

1. Turn the ignition switch to OFF or **Lock**.
2. Leave the operating range with the Honda SMART Key or switch the Honda SMART Key system to deactivation.

Always make sure the ignition switch is OFF.

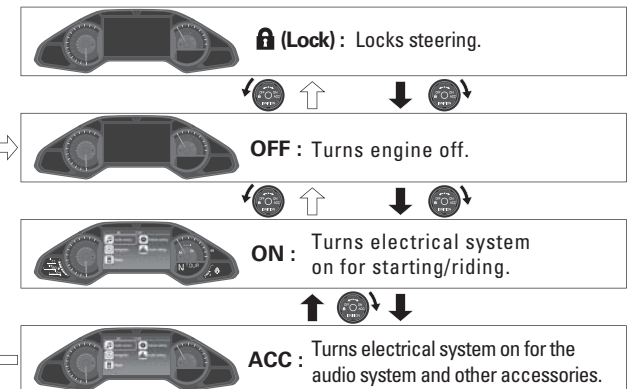

: Turning the ignition switch clockwise

: Turning the ignition switch counterclockwise

Always check the Owner's Manual for more operating and safety information.

Travel Trunk & Saddlebags

- **GL1800/D/DA** equipped with the travel trunk, saddlebags and fairing pocket.
- **GL1800B/BD** equipped with the saddlebags and fairing pocket.

■ To Open the Travel trunk and Saddlebags

1. Make sure the Honda SMART Key is activated, and then enter the operating range with the Honda SMART Key.

Each compartment can be opened when the Honda SMART key is within the shaded area as shown.

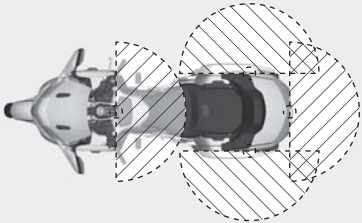

2. To open the travel trunk, press the travel trunk release button.
 - ▶ The travel trunk unlocks and can be opened.
3. To open the saddlebags, press the saddlebag release button.
 - ▶ Each saddlebag unlocks and opens.



■ To Close the Travel Trunk & Saddlebags

To close a compartment, place your hands flat on the edges of its lid and press down until it is firmly closed. Make sure the travel trunk and saddlebags "OPEN" indicator is not blinking before riding.

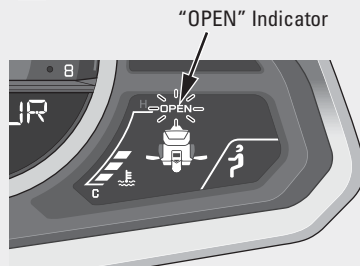

Fairing Pocket & Refueling

Fairing Pocket

■ To Open the Fairing Pocket

1. Make sure the Honda SMART Key is activated, and then enter the operating range with the Honda SMART Key.
2. To open the fairing pocket, press the fairing pocket opener.
 - ▶ The fairing pocket unlocks and can be opened.

Take care not to store the deactivated Honda SMART Key in the fairing pocket.

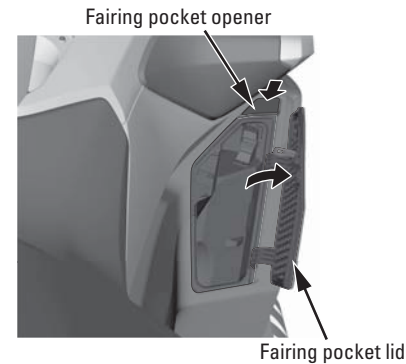

■ To Close the Fairing Pocket

- To close the fairing pocket, push the lid until it is firmly closed.
- ▶ Do not store valuables in the fairing pocket.
 - ▶ Make sure the fairing pocket is closed before riding.

Refueling

■ Opening the Fuel Fill Cap

1. Open the fairing pocket.
2. Slide the fuel lid opener to open the fuel lid.
3. Turn the fuel fill cap counterclockwise and remove it.

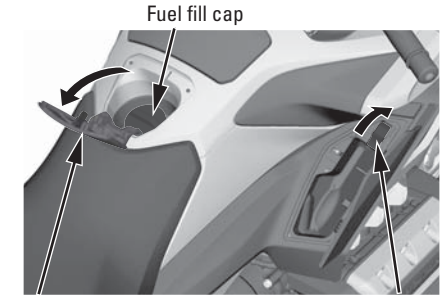

Fuel lid Fuel lid opener

For the refueling procedure, refer to the Owner's Manual.

■ Closing the Fuel Fill Cap

1. After refueling, be sure to tighten the fuel fill cap firmly by tighten it clockwise until it clicks.
2. Close the fuel lid by pushing it until it locks.
3. Close the fairing pocket.

Walking Speed Mode (GL1800BD/D/DA)

The Walking Speed mode assists the rider with getting the motorcycle into or out of tight areas by maneuvering the motorcycle at slow speed.

► Operate the motorcycle's engine only in a well-ventilated area.

Make sure there are no obstacles or people in the area. Avoid steep or uneven surfaces.

Carrying a passenger while in Walking Speed mode is not recommended because it makes balance and control more difficult to maintain.

1. Sit astride the motorcycle, in your normal riding position, with both feet on the ground.
2. Make sure the transmission is in neutral (**N** indicator is on) and the side stand is up.
3. Start the engine.
 - For the engine starting procedure, refer to the Owner's Manual.
4. Press the Walking Speed mode switch while applying the brake lever or pedal. The Walking Speed mode indicator is displayed.

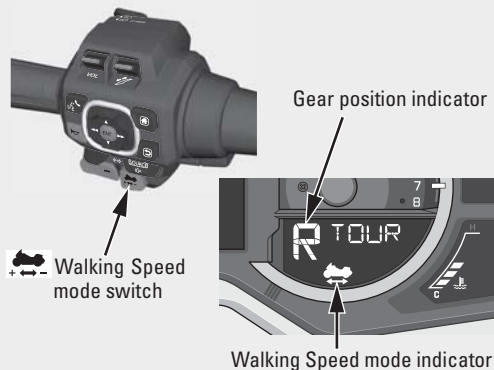

5. To move the motorcycle backward, press and hold the shift down switch (-), and then release the brakes.
To move the motorcycle forward, press and hold the shift up switch (+), and then release the brakes.

- The motorcycle will move forward/backward as long as you hold one of the shift switches
- When the shift up switch (+) (forward) is pressed, "F" is displayed on the gear position indicator.
When the shift down switch (-) (backward) is pressed, "R" is displayed on the gear position indicator.

- It may take a few seconds before the motorcycle starts to move.
- When the engine is stopped in Walking Speed mode, the clutch will disengage. This will cause the motorcycle to abruptly lose traction.
- While in Walking Speed mode, do not press the engine stop switch except in an emergency. This will cause the motorcycle to abruptly lose traction.

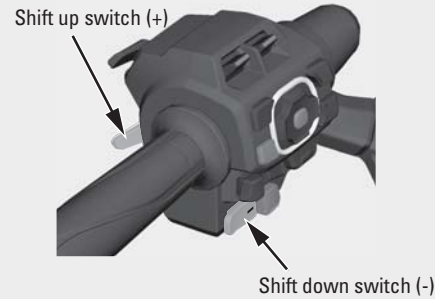

Guide the motorcycle cautiously, using your legs to maintain balance. Use extreme care to maintain balance while in Walking Speed mode on loose surfaces (sand, dirt, gravel) or slick pavement.

6. To stop the motorcycle, apply the brake lever or pedal.
7. To end Walking Speed mode, apply the brake lever or pedal. After the motorcycle has stopped, press the Walking Speed mode switch while operating the brake lever or pedal, or press the N switch. Make sure the Walking Speed mode indicator turns off and the **N** indicator comes on.

Always check the Owner's Manual for more operating and safety information.

Moving in Reverse (GL1800)

Your motorcycle's reverse system allows you to back out of a parking space at slow speed. Make sure there are no obstacles or people in the direction of travel. Avoid steep or uneven surfaces. Carrying a passenger while reversing is not recommended because it makes balance and control more difficult to maintain.

1. Sit astride the motorcycle, in your normal riding position, with both feet on the ground.
2. Make sure the transmission is in neutral (**N** indicator is on) and the side stand is up.
3. Start the engine.
 - For the engine starting procedure, refer to the Owner's Manual.
4. Press the Reverse mode switch to turn on the reverse mode.
 - If the engine is not running, the reverse system cannot be activated.

8. After your motorcycle has stopped, press the Reverse mode switch to turn off the system. Make sure the **N** indicator comes on.

Reverse System Overload

The Reverse mode is designed to move the motorcycle at a constant slow speed. If the motorcycle begins moving slower or faster than this speed because of obstacles or a steep pavement angle, press the Reverse mode switch to turn off the system and carefully roll the motorcycle to a more level, unobstructed surface, and then start again.

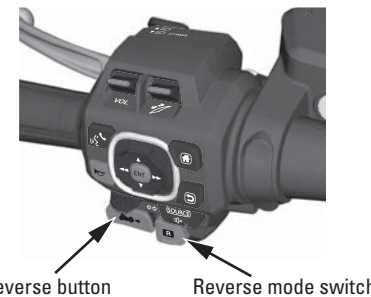

5. When you are ready to back up, press and hold the Reverse button. The motorcycle will move in reverse as long as you hold the button down. ("R" is displayed on the gear position indicator.) To prevent battery discharge, do not press the Reverse button more than 1 minute.
6. Guide the motorcycle backward cautiously, using your legs to maintain balance. Use extreme care to maintain balance while reversing on loose surfaces (sand, dirt, gravel) or slick pavement.
7. Release the Reverse button, and the motorcycle will stop.

Always check the Owner's Manual for more operating and safety information.

Audio & Navigation System Controls

Center Panel

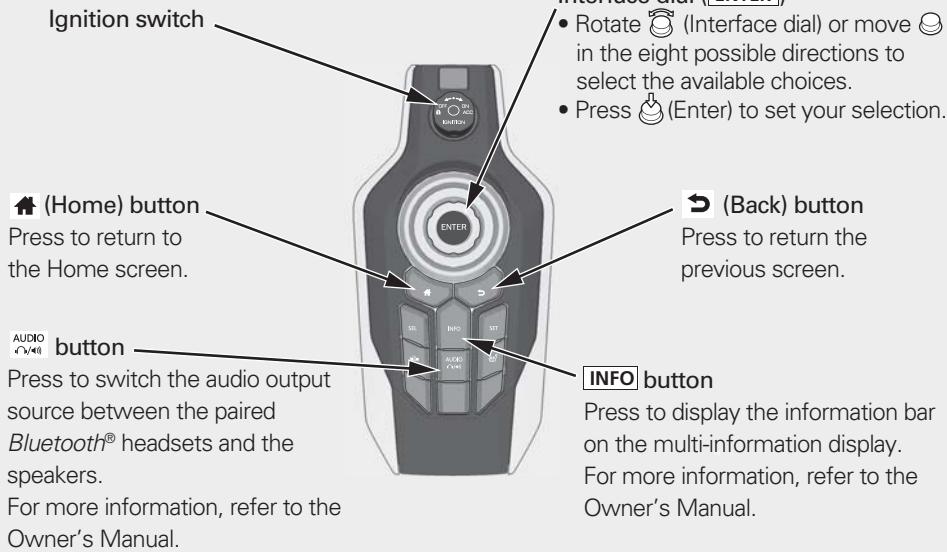

Left handlebar (GL1800BD/D/DA shown)

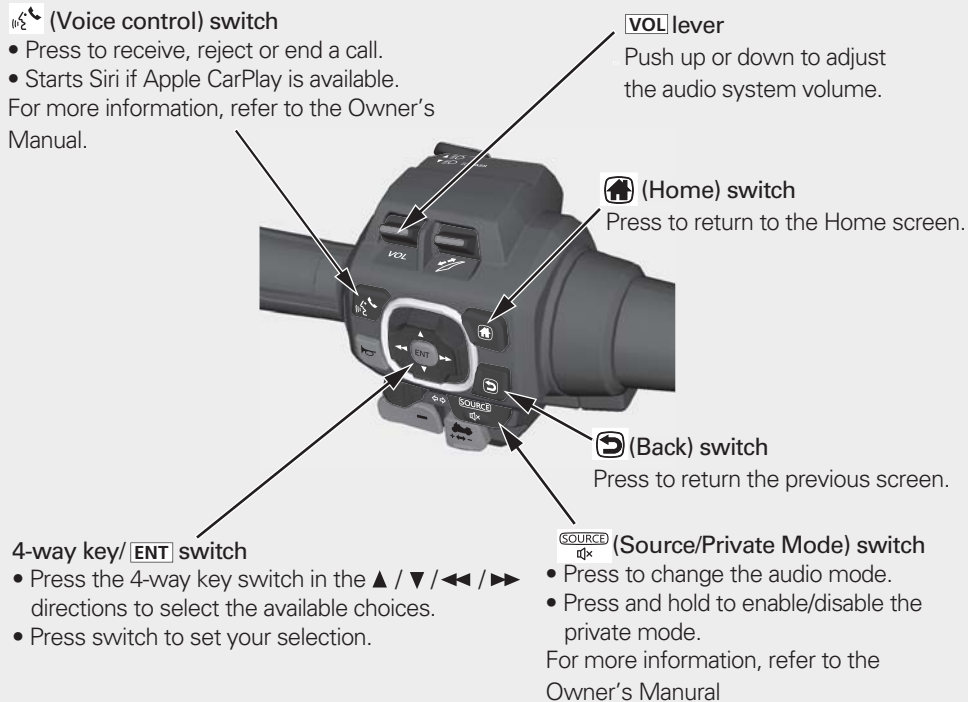

Always check the Owner's Manual for more operating and safety information.

Audio System

The audio system features navigation system, AM/FM radio, audio player (iPhone®, iPod®, USB flash drive or Bluetooth® device), Apple CarPlay™ and Bluetooth® Handsfree Calling. For operations, settings and connections of each mode, refer to the Owner's Manual.

Home Screen

When the ignition switch is turned ON or ACC, the CAUTION message appears on the screen for a few second. Then the Home screen appears.

From this screen, you can go to various functions and setup options.



- **Clock (12-hour display)**
- **Audio Source**
Enters the current audio mode.
- **Navigation**
Displays the navigation screen.
- **Phone**
Enters the phone screen.
- **Vehicle Setting**
Enters the vehicle setting menu screen.
- **Audio Setting**
Enters the audio setting menu screen.
- **Apple CarPlay**
Appears the menu icon when Apple CarPlay is available.

To Change the Audio Mode

Press **SOURCE** switch to change the audio mode. Cycles through the audio modes on the information bar as follows:

[FM] → [AM] → [SXM] (option) → [USB] → [iPod] → [Bluetooth] → [AUX] (option)



Information bar

To Adjust the Volume

You can adjust the volume settings for the speakers and headsets separately.

The system has following unique volume levels. Adjust the volume while in the individual modes.

[Audio] / [Phone] / [Navi] / [Ring tone] / [Siri®] / [Apple CarPlay] / [CB radio (option)]

When you push **VOL** lever up or down, the volume control level appears on the information bar.



Information bar

* iPhone, iPod and Siri are trademarks of Apple Inc.

* The Bluetooth® word mark and logos are registered trademarks owned by Bluetooth SIG, Inc., and any use of such marks by Honda Motors Co., Ltd., is under license.

Always check the Owner's Manual for more operating and safety information.

Navigation System

The navigation system is a highly-sophisticated yet easy-to-use system with visual and voice guidance that uses satellites and a map database to show you where you are and help guide you to a desired destination.

Map Menu

Display the map screen and operate the navigation features.

Select [Navigation] on the Home screen, then press  (Enter) on the center panel or press [ENT] switch on the left handlebar.

The map menu will be displayed on the bottom of the maps screen.



Map Scroll

Move the interface dial up, down, left, right and on diagonals to scroll the map.

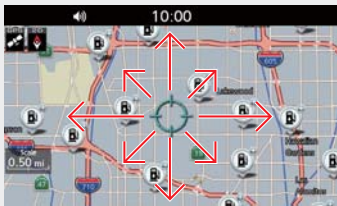

Zoom In/Out

Rotate the interface dial clockwise/counterclockwise to zoom in or out of the map.

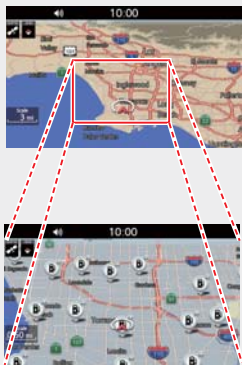

Navigation Menu

Use main navigation functions, change settings and view useful information. From the map menu, select [Menu]. The navigation menu will be displayed.



- Go Home**
Sets the route to your home location.
- Destination Input**
Selects your destination by selecting one of your favorite destinations or recent destinations, selecting a point of interest, entering an address, or selecting a location on the map.
- Emergency**
Searches for emergency services or displays information about your current location.
- Routes**
Creates and saves the route with multiple destinations, or edits the current route.
- Information**
Displays the different information.
- Setup**
Customizes the settings related to the navigation function.

Navigation System

Map Screen Legend

Map orientation

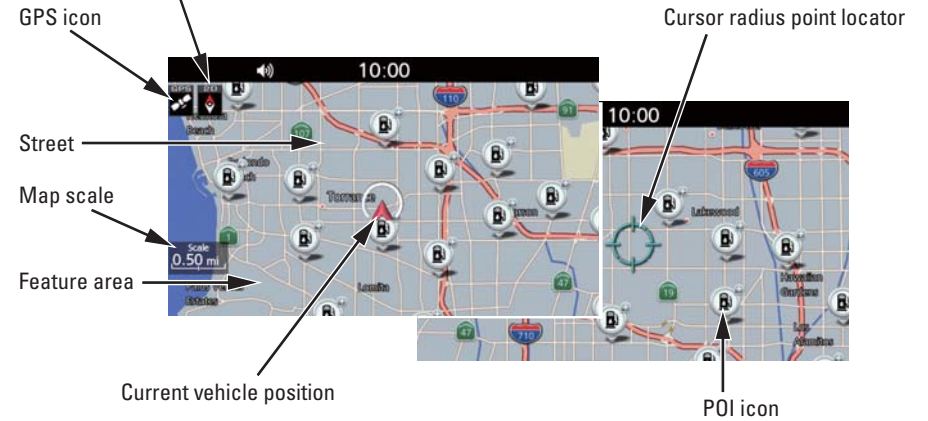
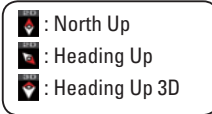

During Route Guidance

Map Screen (Route List Mode)

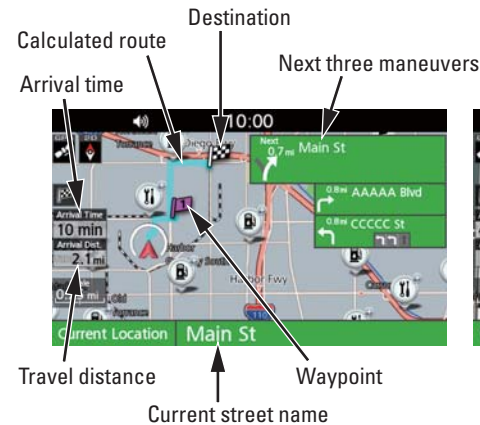

Guidance Screen

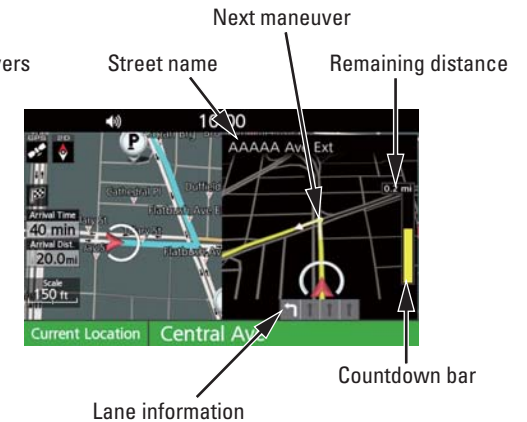

* For safety reasons, some of the system operation and controls are automatically disabled while your motorcycle is in motion.

* Only the Navigation System's handlebar controls and audio system controls continue to operate while riding.

Always check the Owner's Manual for more operating and safety information.